

Product Type: Direct crimp connectors

Product Name:DL508H30F-03-1200

Product Description: Crosssection:0.5-1.25mm²/20-16AWG Ratedcurrent:8A CE

Product Size

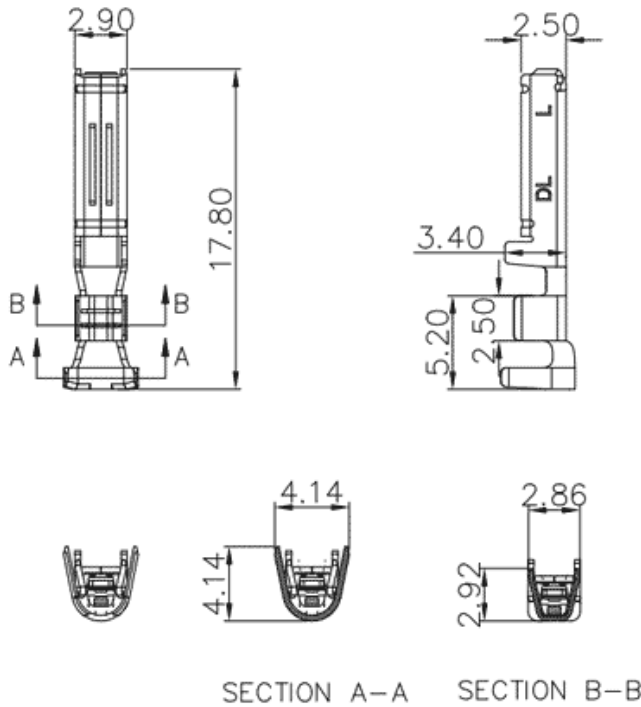

Parameters

<input checked="" type="checkbox"/> SUPU ID	DL508H30F-03-1200
<input checked="" type="checkbox"/> Pitch	-
<input checked="" type="checkbox"/> Number of levels	-
<input checked="" type="checkbox"/> Number of connections	-

<input checked="" type="checkbox"/> Connection method	Cold pressing
<input checked="" type="checkbox"/> Protection Level	IP20
<input checked="" type="checkbox"/> Operating temperature range	-40~+105°C
<input checked="" type="checkbox"/> Insulation material	-
<input checked="" type="checkbox"/> Insulation material group	-
<input checked="" type="checkbox"/> Contact material	Copper alloy
<input checked="" type="checkbox"/> Contact plating	Sn,Plated

Technical data

<input checked="" type="checkbox"/> IEC Rated Current	8A
<input checked="" type="checkbox"/> IEC Rated Voltage	-
<input checked="" type="checkbox"/> Overvoltage category	III/III/II
<input checked="" type="checkbox"/> Degree of pollution	-
<input checked="" type="checkbox"/> Rated impulse voltage	-
<input checked="" type="checkbox"/> UL Rated Current	8A
<input checked="" type="checkbox"/> UL Rated Voltage	-
<input checked="" type="checkbox"/> Conductor cross section rigid	-
<input checked="" type="checkbox"/> Conductor cross section flexible	0.5-1.25mm ²
<input checked="" type="checkbox"/> Conductor cross section flexible,with ferrule	-
<input checked="" type="checkbox"/> Locking screw Specification	-
<input checked="" type="checkbox"/> Locking screw torque	-
<input checked="" type="checkbox"/> Fixed Screw Specification	-
<input checked="" type="checkbox"/> 固定螺钉扭矩	-
<input checked="" type="checkbox"/> Stripping length	4-5mm

Use group

-

Rated cross section

20-16AWG

Commercial data

Order No

DL508H30F-03-1200

Ningbo SUPU Electronics Co., Ltd.

Address: No. 150, Xinxing 4th Road, High-tech Industrial Development Zone,
Cixi City, Zhejiang Province, China

Zip code: 315303

Switchboard: +86 574-63288158

Fax: +86 574-63288170

E-mail:supucontact@supu.cn

Service Hotline: 400-626-6336

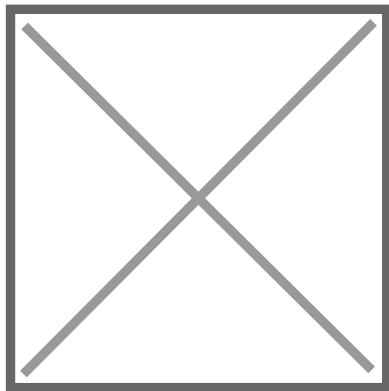

Wechat

Date:2026-05-03 19:31

The right to modify data belongs to SUPU.