

Product Type: Terminal block

Product Name: X2-A20P-NZ

Product Description: 50mm ordinary base, Horn connector input, MC-DTP/TP terminal 20 outputs, no indicator light relay module

Product Size

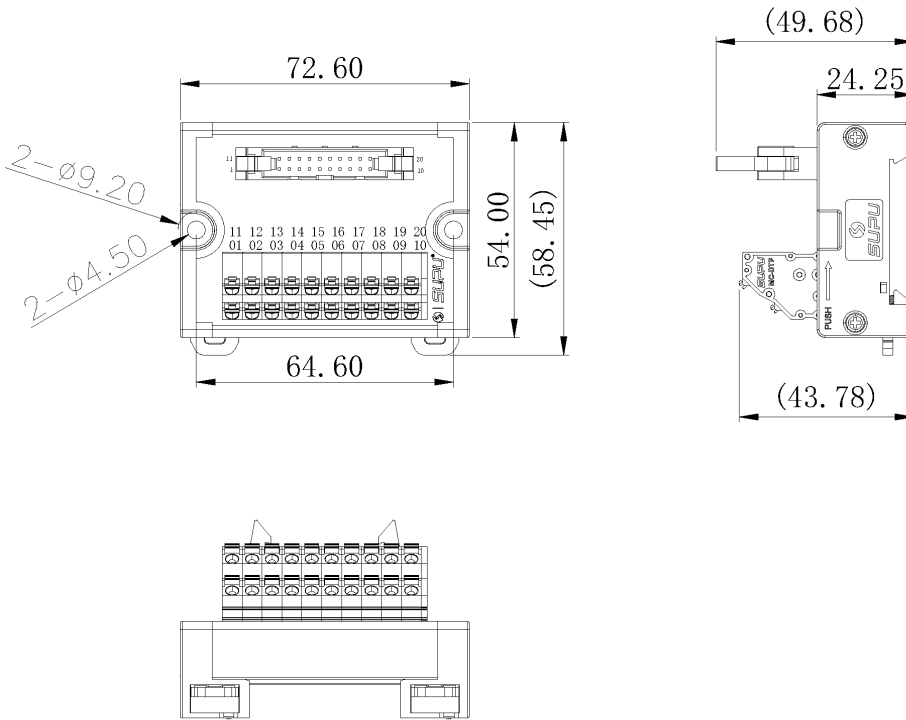

Parameters

⌘ SUPU ID	X2-A20P-NZ
⌘ Number of connections	20
⌘ Protection Level	IP20

☞ Operating temperature range	-20°C-+70°C
-------------------------------	-------------

☞ Mounting Type	35mm DIN/螺钉安装
-----------------	---------------

Technical data

☞ Overvoltage category	II
------------------------	----

☞ Degree of pollution	2
-----------------------	---

☞ Stripping length	9-10mm
--------------------	--------

☞ Cable cross section (AWG)	500VAC/1min
-----------------------------	-------------

☞ Insulation Resistance	500MΩ
-------------------------	-------

☞ Wire Range	28-16AWG
--------------	----------

☞ Coil Current	/
----------------	---

☞ Load Current	1A
----------------	----

☞ Coil Voltage	/
----------------	---

Commercial data

☞ Order No	X2-A20P-NZ
------------	------------

☞ Packing unit	PCS
----------------	-----

☞ Minimum order quantity	5
--------------------------	---

Ningbo SUPU Electronics Co., Ltd.

Address: No. 150, Xinxing 4th Road, High-tech Industrial Development Zone,
Cixi City, Zhejiang Province, China

Zip code: 315303

Switchboard: +86 574-63288158

Fax: +86 574-63288170

E-mail:supucontact@supu.cn

Ningbo SUPU Electronics Co., Ltd.

Service Hotline: 400-626-6336



Wechat

Date:2026-06-24 13:39

The right to modify data belongs to SUPU.